



DESI Power + DESI Power Foundation
Sustainable Rural Development
Electricity, Water, Farming, Enterprises, Clean Cooking, Hygiene and Training



About DESI Power

(www.despower.com)

- EmPower Partnership Projects: since 1996
- Field-testing and adapting energy technologies for rural energy applications.
- Building, owning and operating decentralised power generation (biomass, biogas, PV and Hybrid), Micro Grids (probably the first one in India) and Tiny Grids.
- Project development and "Engineering, Procurement, Construction, Operation and Maintenance" [EPCOM] services for village plants.
- Load development and management.
- Financial engineering, project packaging and fund raising.
- Training and skills development of villagers.



DESI Power + DESI Power Foundation
Sustainable Rural Development
Electricity, Water, Farming, Enterprises, Clean Cooking, Hygiene and Training



Contribution to Meet Sustainable Development Goals (SDG) for Villages





DESI Power EmPower Partnership: Integration of Resources, Technologies and Value-addition

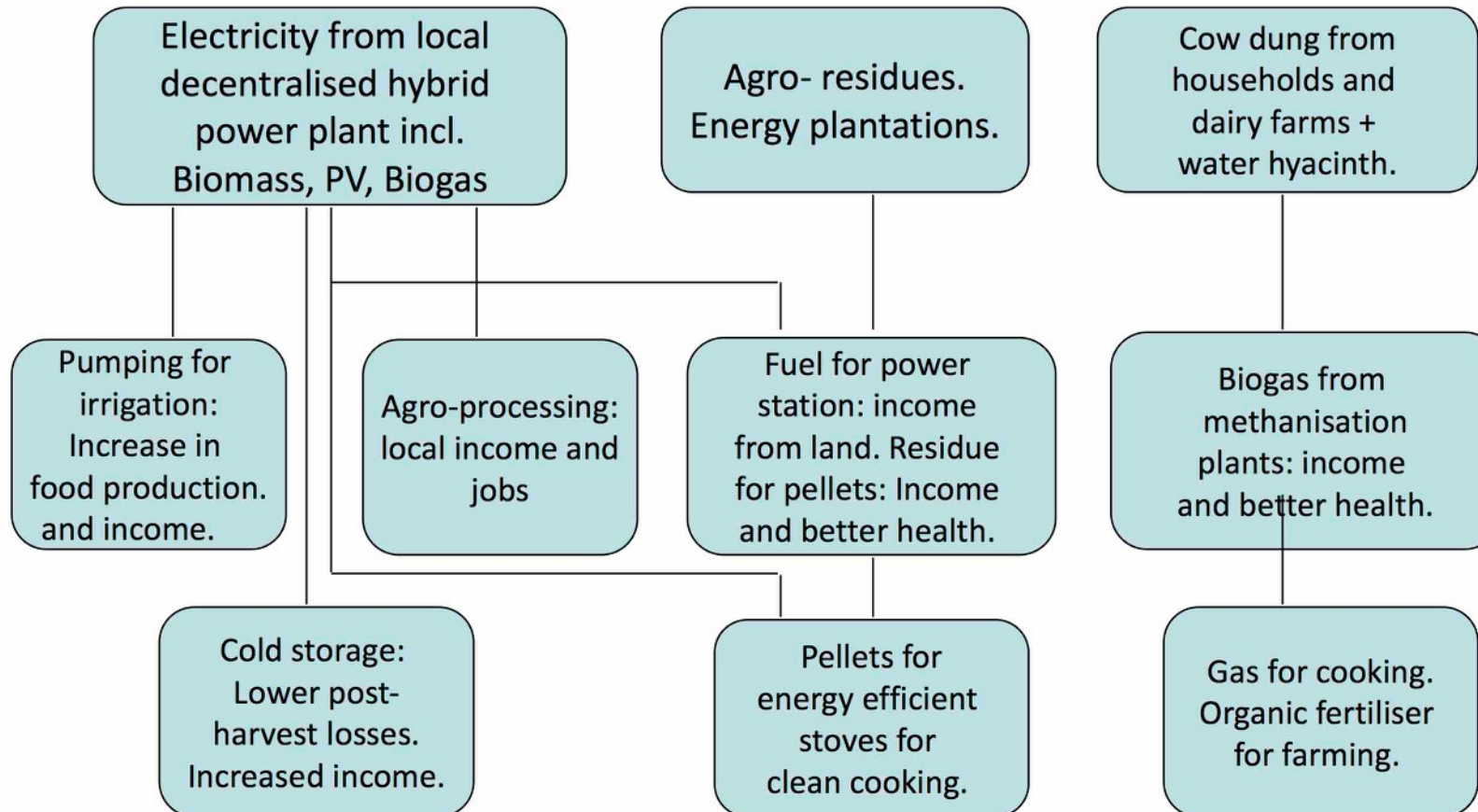



DESI Power + DESI Power Foundation
Sustainable Rural Development
Electricity, Water, Farming, Enterprises, Clean Cooking, Hygiene and Training



DESI Power Power Plants and Micro Grids: Hybrid, Biomass and Solar PV.

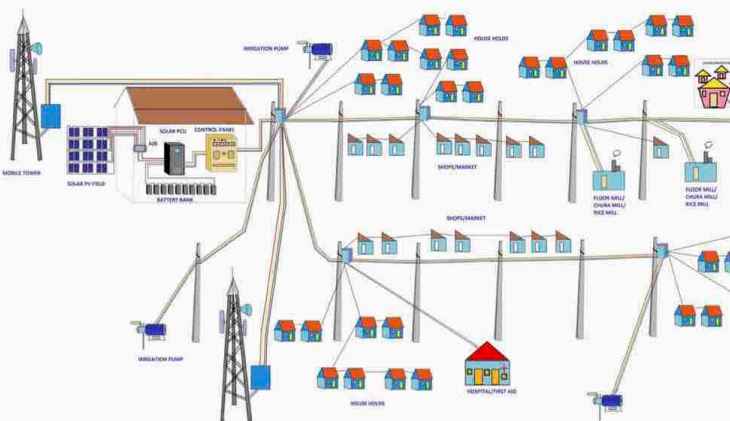
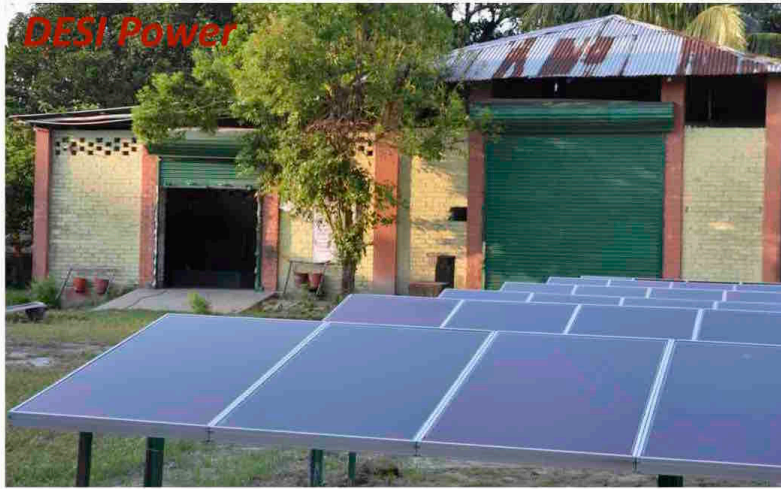



DESI Power + DESI Power Foundation
Sustainable Rural Development
Electricity, Water, Farming, Enterprises, Clean Cooking, Hygiene and Training



DESI Power Chakai: Hybrid Power Plant with Base Load, Micro Grid and Pumps





DESI Power + DESI Power Foundation Sustainable Rural Development

Electricity, Water, Farming, Enterprises, Clean Cooking, Hygiene and Training



DESI Power: AC and DC Tiny Grids for Small Captive Loads

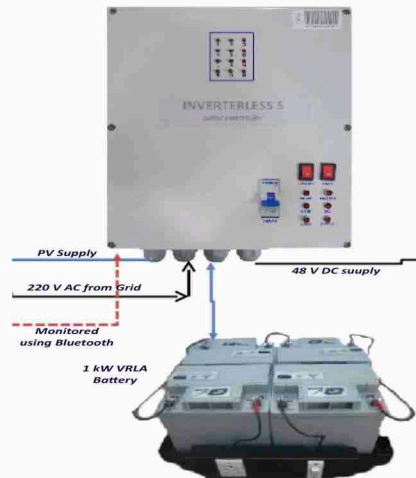
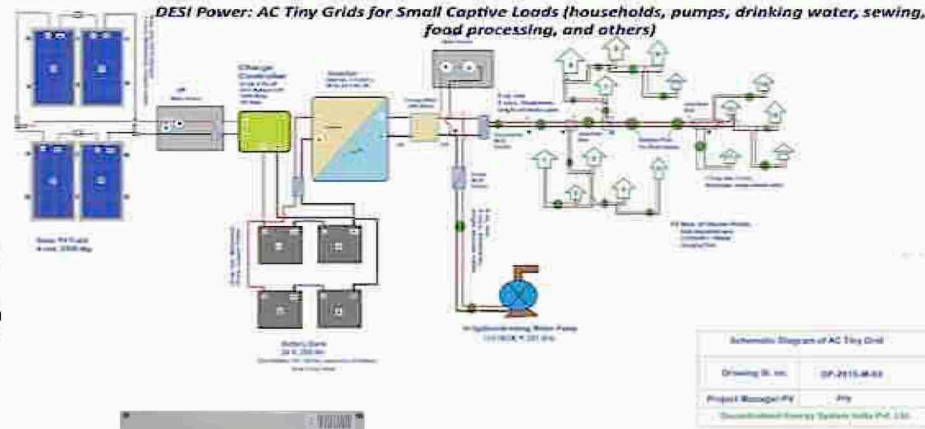
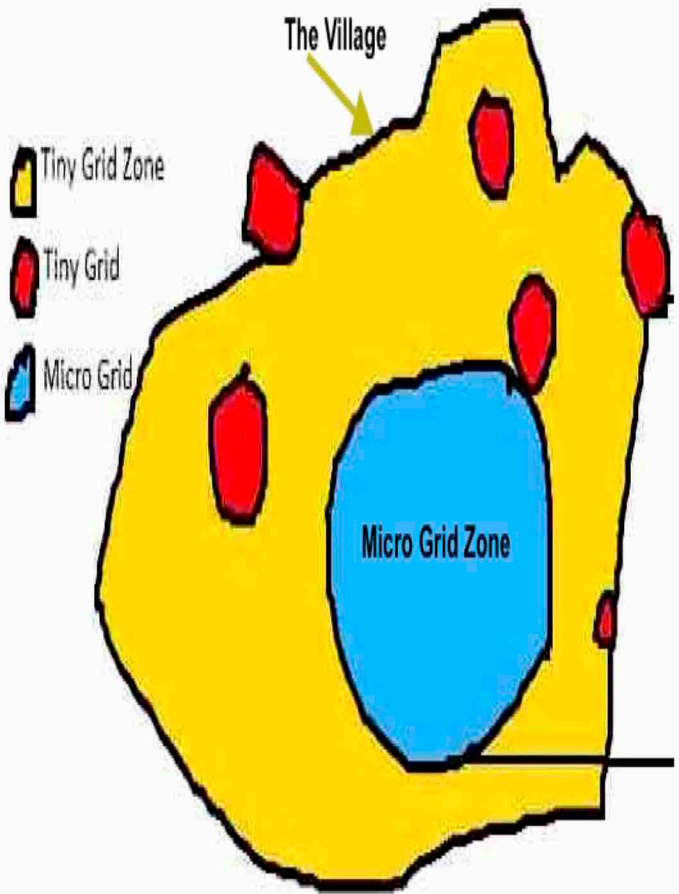



DESI Power + DESI Power Foundation
Sustainable Rural Development
Electricity, Water, Farming, Enterprises, Clean Cooking, Hygiene and Training



Tiny Grid: irrigation water, lighting and mobile charging

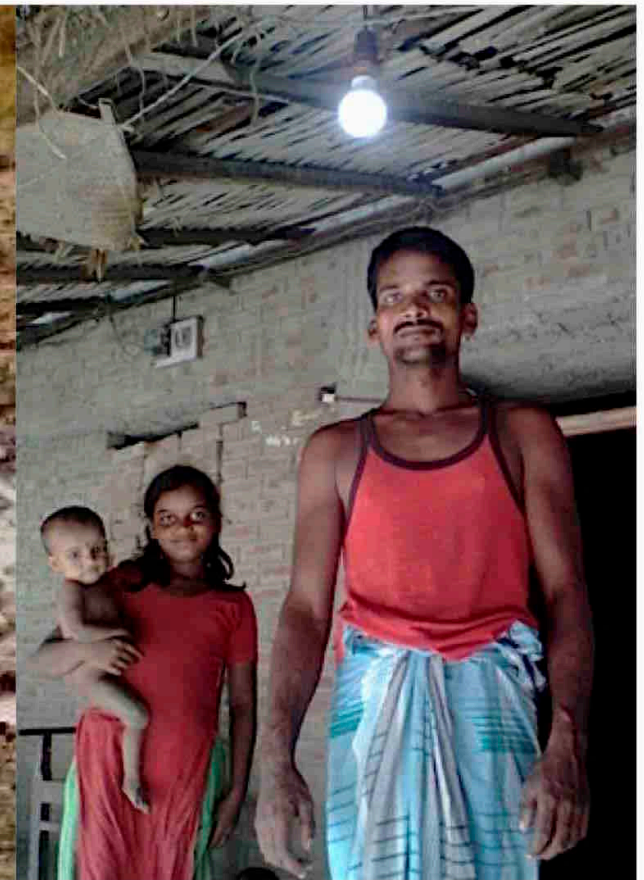



DESI Power + DESI Power Foundation
Sustainable Rural Development
Electricity, Water, Farming, Enterprises, Clean Cooking, Hygiene and Training



Tiny Grid: mobile pumping for irrigation water

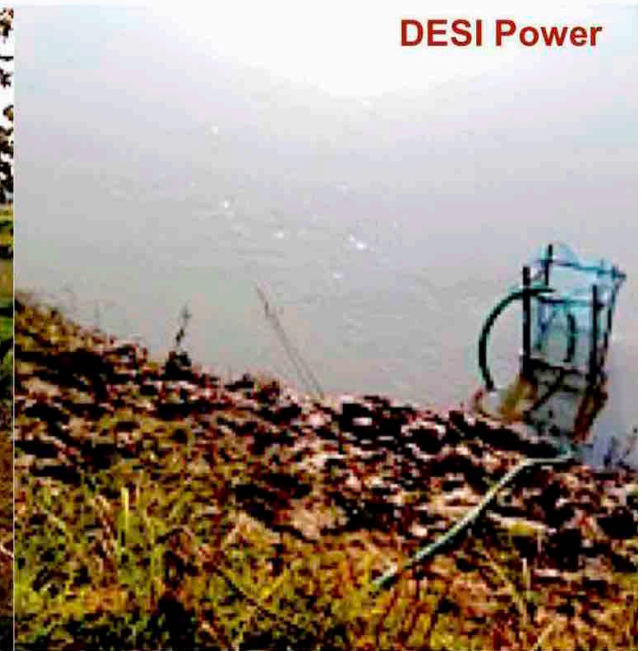
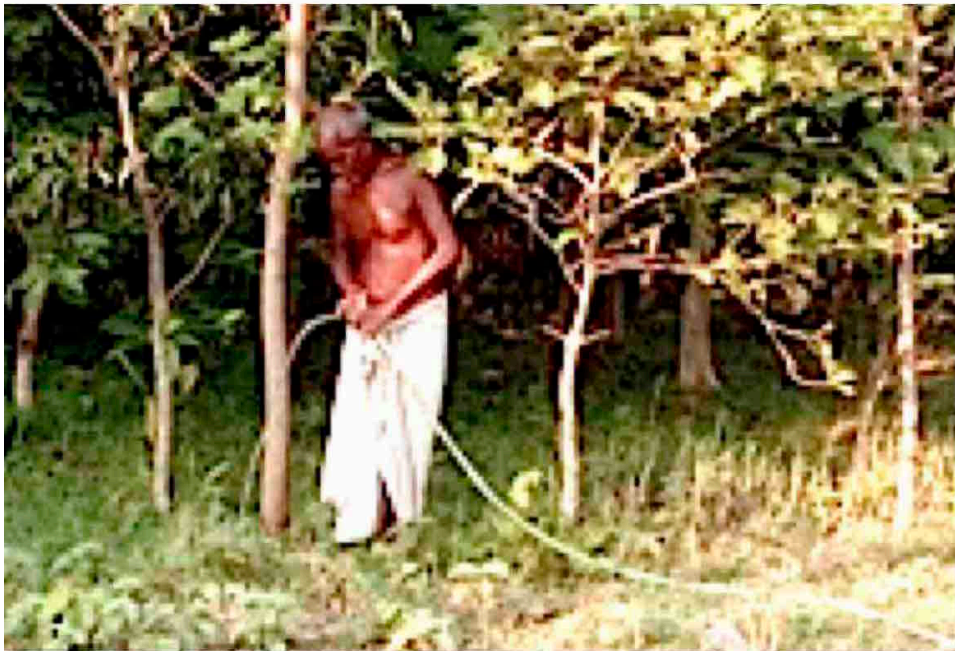



DESI Power + DESI Power Foundation
Sustainable Rural Development
Electricity, Water, Farming, Enterprises, Clean Cooking, Hygiene and Training



DESI Power: Direct Impacts of DESI Power Tiny Grid Pilot Project

Impacts of 40 Pilot Units of Tiny Grids (in May 2017)		
Description		Nos
No of Households		510
Direct beneficiaries in Households		2550
Direct beneficiaries from Irrigation pumps		35
Direct beneficiaries from productive loads:		15
Direct beneficiary: Village staff with Family)		30
Direct beneficiary: DESI Power Staff with Family		35
Direct beneficiary of pilot projects of DESI Power Foundation using TGs:		385
Total number of Direct Beneficiaries of REPIC Pilot TG Units in May 2017		3050
Direct Investment for making the Impacts		
Investment in 40 TG Units	Rs	8'000'000
	CHF	123'077
Specific Investment per beneficiary	Rs/cap	2'623
	CHF/cap	40



DESI Power + DESI Power Foundation

Sustainable Rural Development

Electricity, Water, Farming, Enterprises, Clean Cooking, Hygiene and Training



Biomass generation, procurement, processing and management



Biomass management: energy plants, plantations and agro - residues

HS_Oct17



DESI Power + DESI Power Foundation
Sustainable Rural Development
Electricity, Water, Farming, Enterprises, Clean Cooking, Hygiene and Training



DESI Power Chakai: Base Load for Gasifier-Engine and PV to Supply Clean Cooking Fuel





DESI Power + DESI Power Foundation
Sustainable Rural Development
Electricity, Water, Farming, Enterprises, Clean Cooking, Hygiene and Training



People





DESI Power + DESI Power Foundation
Sustainable Rural Development
Electricity, Water, Farming, Enterprises, Clean Cooking, Hygiene and Training



DESI MNATRA Training Centre, Araria: in the class room, in the field and on the job.





DESI Power + DESI Power Foundation
Sustainable Rural Development
Electricity, Water, Farming, Enterprises, Clean Cooking, Hygiene and Training



DESI MANTRA Training Centre: Capacity Building and Empowerment

Class Room Training:



On job training at site



Class room training



DESI MANTRA trained women working with DESI Power

Village Plant Manager at work

On site technical training of trainees at Galyari site